

Einzelteilliste

Liste de pieces

Onderdelenlijst

Part list

Lista de componentes

Elenco componenti

Dellista

Seznam dílů

Del-liste

Osaluettelo

Κατάλογος εξαρτημάτων

Delliste

Lista części

DE

FR

NL

GB

ES

IT

SE

CZ

DK

FI

GR

NO

PL

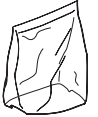

R1

G I

A

5x

M

M

R2

X

X

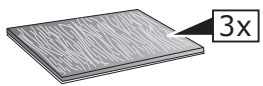
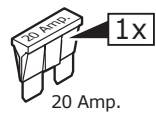
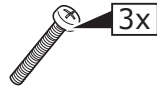
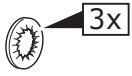
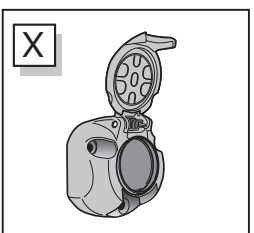

INFO

	BK	BN	BU	GY	GN	WH	YE	OG	PE	PI	RD
DE	Schwarz	Braun	Blau	Grau	Grün	Weiß	Gelb	Orange	Violett	Rosa	Rot
FR	Noir	Marron	Bleu	Gris	Vert	Blanc	Jaune	Orange	Violet	Rose	Rouge
NL	Zwart	Bruin	Blauw	Grijs	Groen	Wit	Geel	Oranje	Paars	Roze	Rood
GB	Black	Brown	Blue	Grey	Green	White	Yellow	Orange	Purple	Pink	Red
ES	Negro	Marrón	Azul	Gris	Verde	Bianco	Amarillo	Naranja	Morado	Rosa	Rojo
IT	Nero	Marrone	Blu	Grigio	Verde	Bianco	Giallo	Arancione	Viola	Rosa	Rosso
SE	Svart	Brun	Blå	Grå	Grön	Vit	Gul	Orange	Lila	Rosa	Röd
CZ	Černá	Hnědá	Modrá	Šedá	Zelená	Bílá	Žlutá	Oranžová	Fialová	Růžová	Červená
DK	Sort	Brun	Blå	Grå	Grøn	Hvid	Gul	Orange	Lilla	Pink	Rød
FI	Musta	Ruskea	Sininen	Harmaa	Vihreä	Valkoinen	Keltainen	Oranssi	Purppura	Vaaleanpunainen	Punainen
GR	Μαύρο	Καφέ	Μπλε	Γκρι	Πράσινο	Λευκό	Κίτρινο	Πορτοκαλί	Μοβ	Ροζ	Κόκκινο
NO	Svart	Brun	Blå	Grå	Grønn	Hvit	Gul	Oransje	Lilla	Rosa	Rød
PL	Czarny	Brązowy	Niebieski	Szary	Zielony	Biały	Żółty	Pomarańczowy	Purpurowy	Różowy	Czerwony

ROUTING

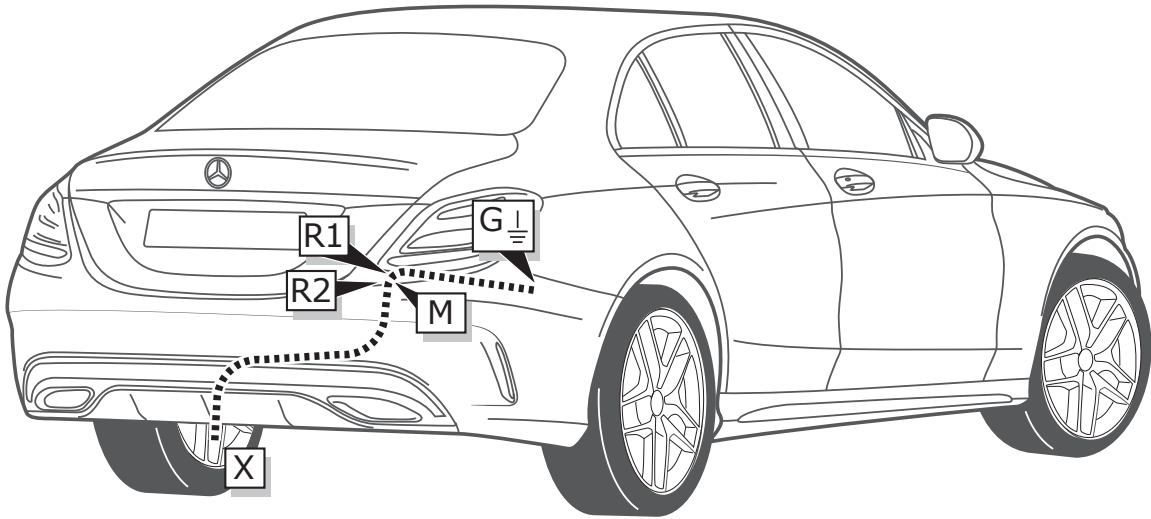

1

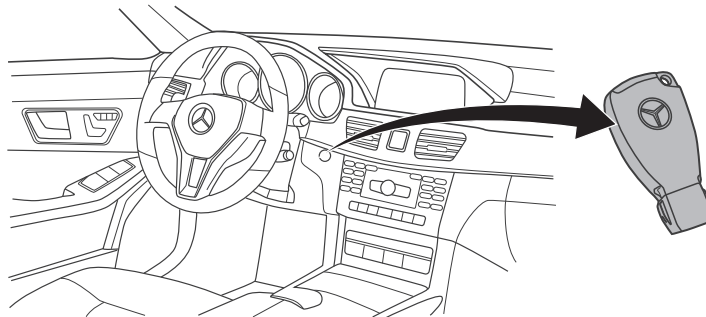

2

Keyless-go

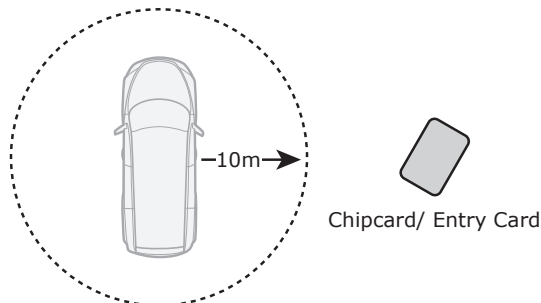

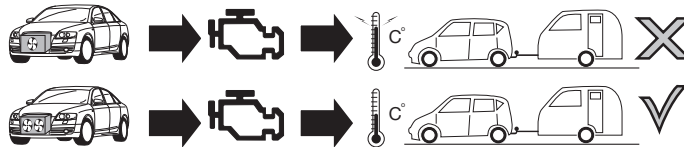
**ACHTUNG!**

(DE)

Die Kühlerleistung des Fahrzeuges muß bei Nachrüstung einer Anhängerkupplung möglicherweise erhöht werden! Bitte unbedingt Herstellerangaben beachten!!

ATTENTION!

(FR)

Il peut s'avérer nécessaire d'augmenter la puissance du radiateur du véhicule lorsque celui est équipé ultérieurement d'un attelage remorque! Respecter impérativement les instructions du constructeur!!

ATTENTIE!

(NL)

Het koelvermogen van het voertuig moet mogelijk worden verhoogd als achteraf een aanhangerkoppeling wordt aangebracht! Absoluut de fabrieksopgaven in acht nemen a.u.b.!!

ATTENTION!

(GB)

The vehicle's cooling capacity may have to be increased when retrofitting a trailer coupling! You must observe the manufacturer's instructions!!

¡ATENCIÓN!

(ES)

¡Es posible que haya que aumentar la capacidad del radiador en caso de reequipar un acoplamiento de remolque! ¡Rogamos tener en cuenta las instrucciones de fabricante sin falta!

ATTENZIONE!

(IT)

La capacità di raffreddamento del veicolo, quando si applica un gancio di traino, si deve possibilmente aumentare! Si prega di osservare tassativamente le indicazioni del produttore!!

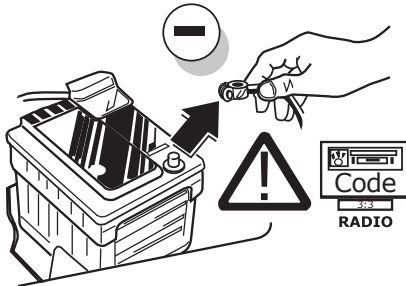

(DE)

Um Störungen und Schäden am Bordnetz zu vermeiden, muss die Massepolklemme unbedingt vor Beginn aller Arbeiten von der Fahrzeugbatterie getrennt werden! Insbesondere bei Arbeiten und Anschlüssen am CAN-Datenbus kann bei nicht abgeklemmter Batterie sowohl das Anhängermodul als auch das fahrzeugeitige Bordnetzsteuergerät beschädigt werden! Bitte Herstellervorschriften beim Ab- und Anklemmen der Fahrzeugbatterie beachten!

(FR)

Afin d'éviter tout dys-fonctionnement ou endom-magement du circuit de bord, il est indispensable de débrancher la pince de masse de la batterie du véhicule avant le début de toute opération! En particulier s'il s'agit de travaux et de branchements effectués sur le bus de données CAN, si la batterie n'est pas débranchée, le module remorque aussi bien que le dispositif de commande de circuit de bord du véhicule risquent d'être endommagés! Veuillez respecter les directives du fabricant lors du branchement et du débranchement de la batterie du véhicule!

(NL)

Om storingen en schade aan de elektrische bedrading te vermijden moet de massapoolklem absoluut vóór aanvang van alle werkzaamheden worden losgekoppeld van de voertuigaccu! Vooral bij werkzaamheden aan aansluitingen op de CAN-databus kan zowel de aanhangermodule als de voertuigzijdige regeleenheid voor de elektrische installatie beschadigd worden, als de accu niet ontkoppeld is! Fabrieksvorschriften bij het vast- en loskoppelen van de voertuigaccu in acht nemen a.u.b.!

(GB)

In order to avoid mal-functions and damage to the vehicle's electrical system the earth terminal must be disconnected from the vehicle's battery before starting work! Both the trailer module and the vehicle's control unit for the electrical system can be damaged during work on the CAN data bus connections if the battery is not disconnected! Please pay attention to the manufacturer's instructions when disconnecting and reconnecting the vehicle's battery!

(ES)

¡Para evitar fallos y defectos en el sistema eléctrico de a bordo es imprescindible separar al terminal de puesta a tierra de la batería del vehículo antes de realizar cualquier trabajo! ¡Particularmente al realizar trabajos y conexiones al bus de datos CAN puede estropearse tanto el módulo para remolques como el regulador del sistema eléctrico de a bordo del vehículo si no se ha desconectado la batería! ¡Rogamos observar las instrucciones del fabricante al conectar y desconectar la batería del vehículo!

(IT)

Per evitare disturbi e danni alla rete di distribuzione elettrica, l'espansione polare a massa deve essere assolutamente scollegata dalla batteria del veicolo prima dell'inizio dei lavori! In particolare durante i lavori e gli allacciamenti al bus di dati CAN, se la batteria non è scollegata si possono danneggiare sia la centralina rimorchio, sia la centralina della rete di distribuzione elettrica del veicolo! Attenersi alle indicazioni del costruttore per scollegare e ricollegare la batteria del veicolo!

Saloon/ Coupe/ Cabriolet

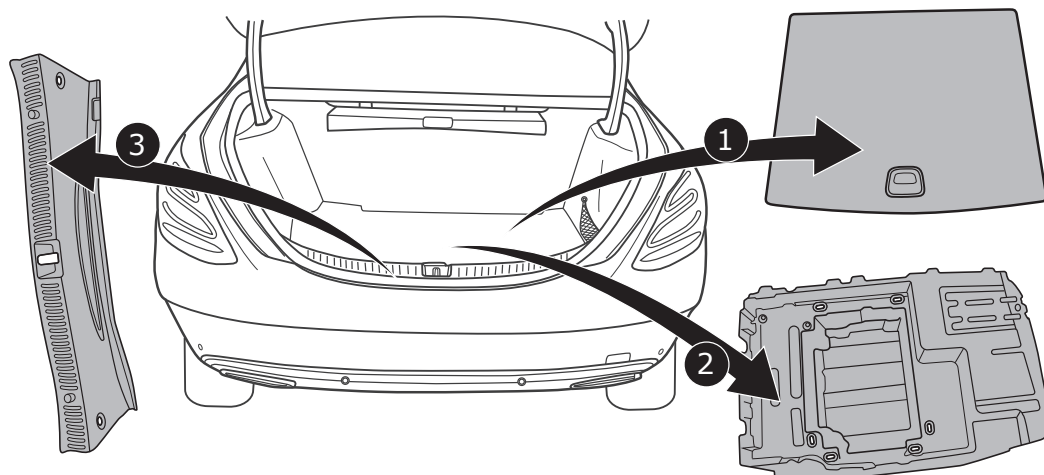

Saloon/ Coupe/ Cabriolet

5

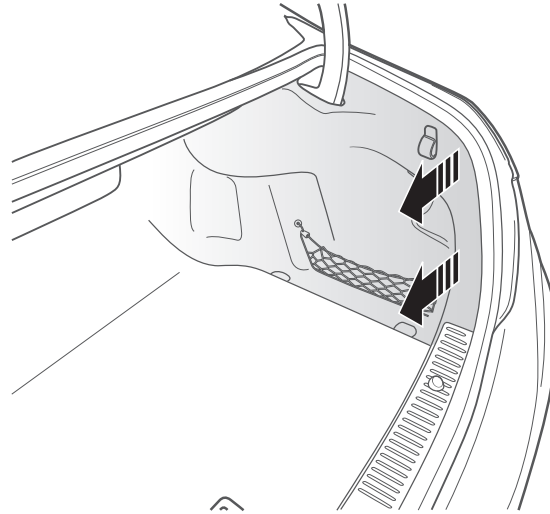
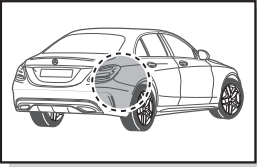

Estate

6

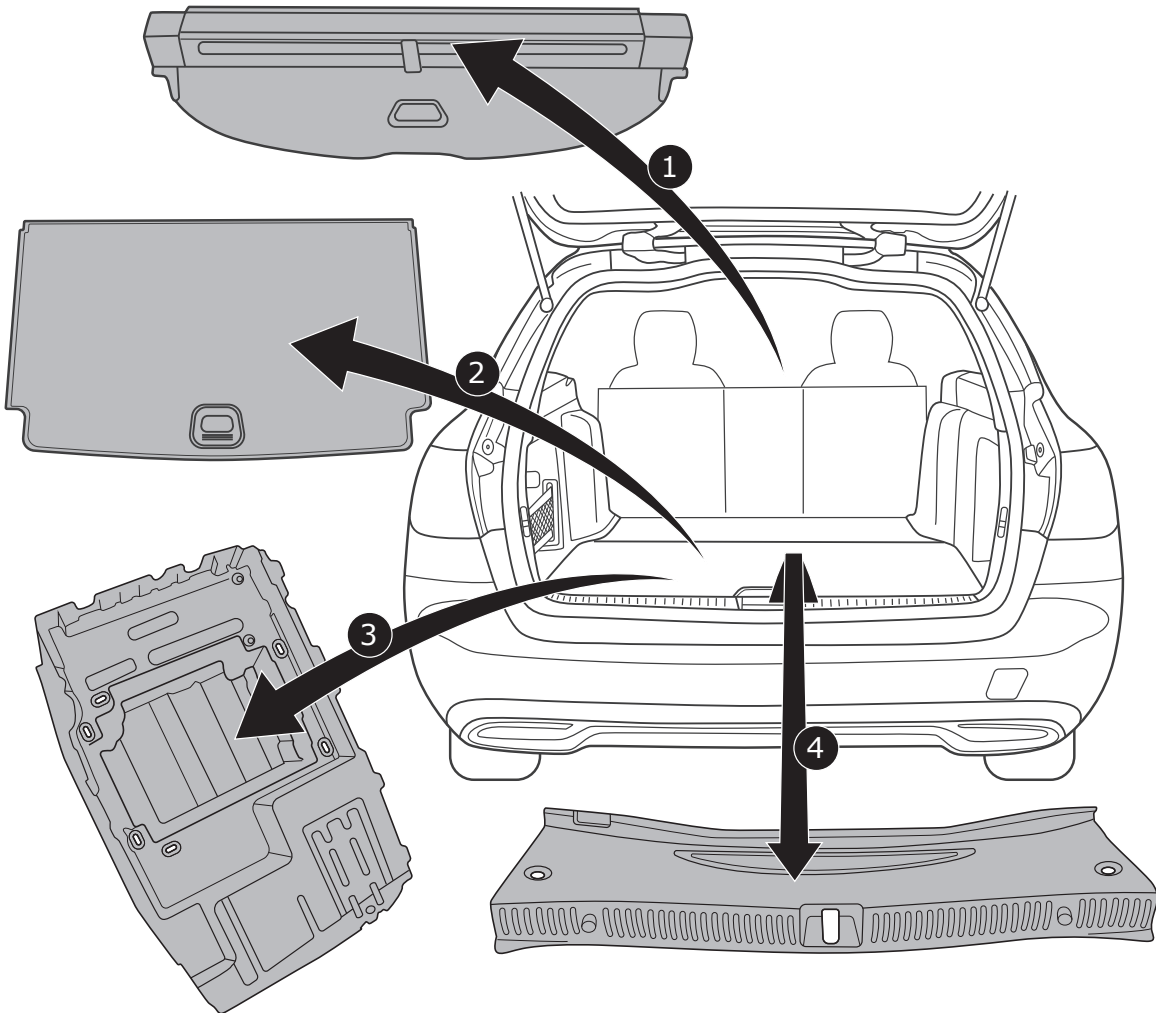

All models

7

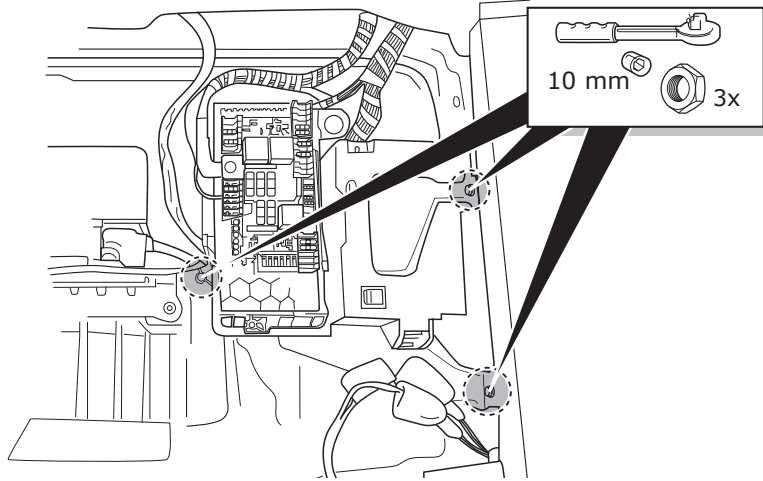
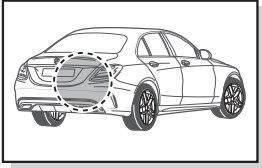

Estate

8

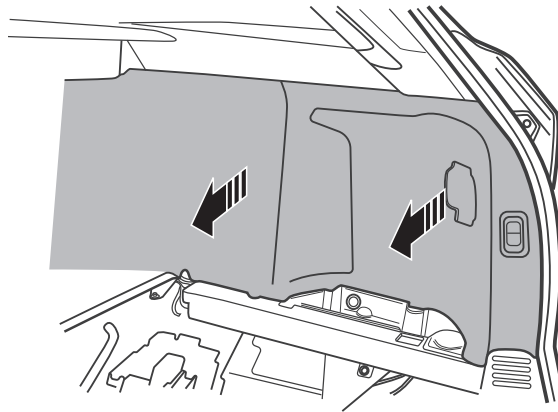
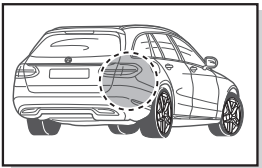

All models

9

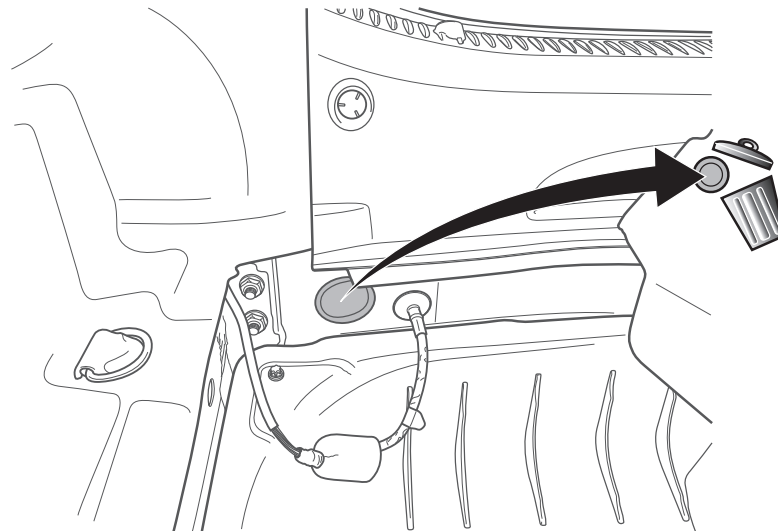
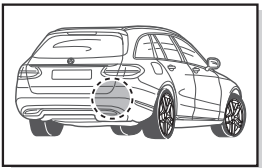
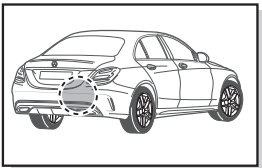

10

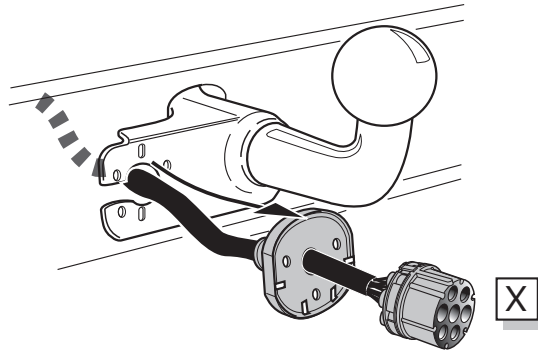

11

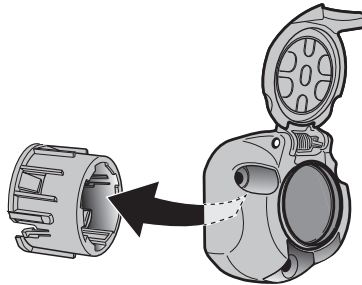

12

- Ⓓ Anschluss Steckdose
- Ⓕ Connection de la prise
- Ⓓ Contactdoos aansluiting
- Ⓕ Socket connection
- Ⓕ Conexión de la caja de enchufe
- Ⓓ Allaccio zoccolo



Page 17

13

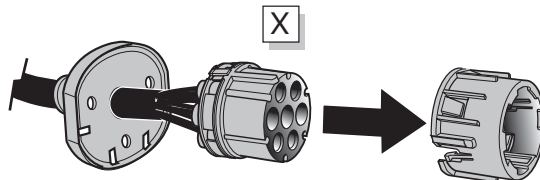

14

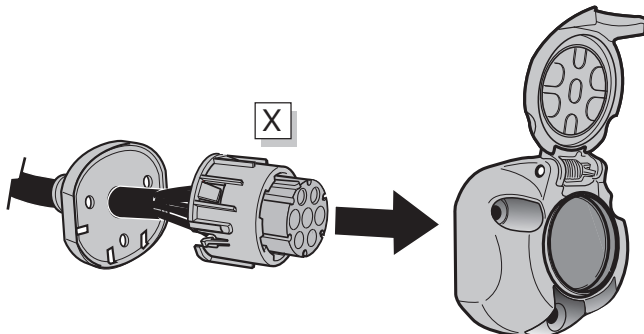

15

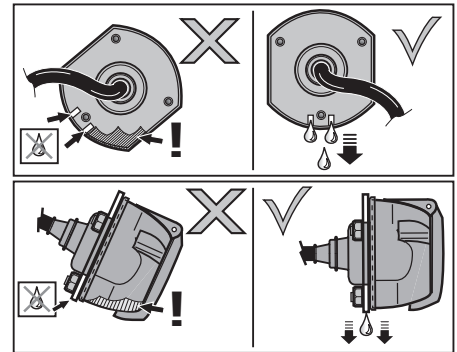
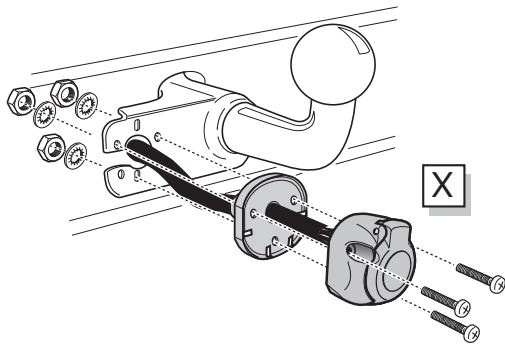

16

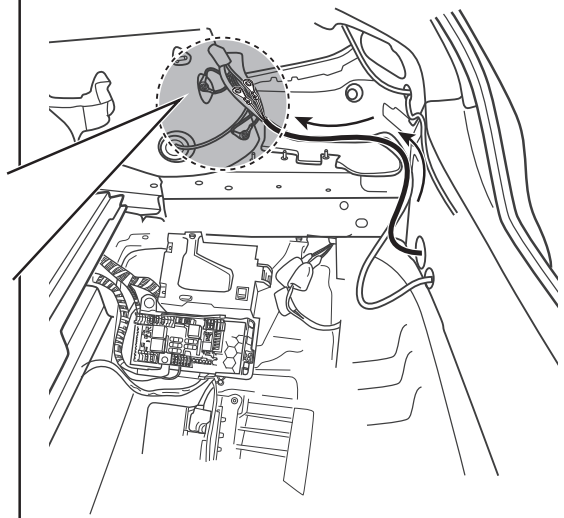
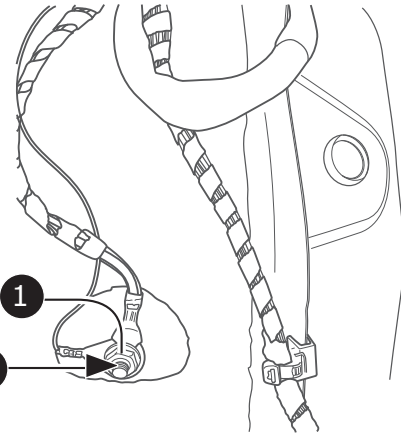
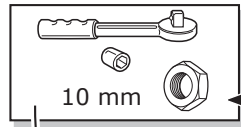
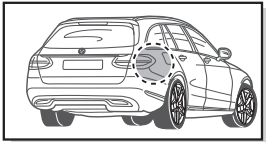
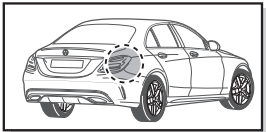

17

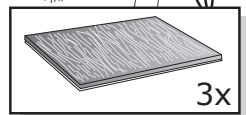
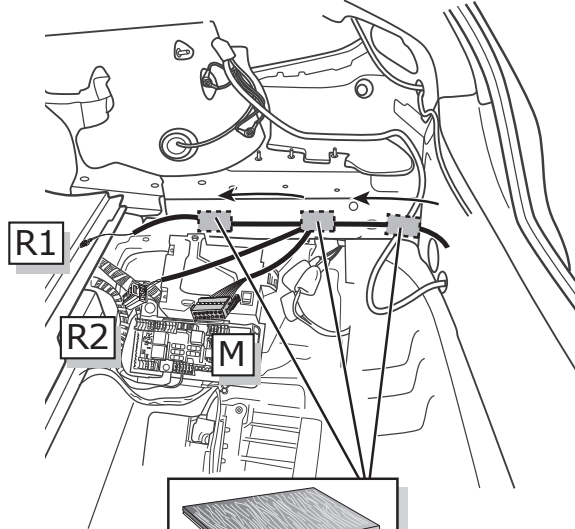
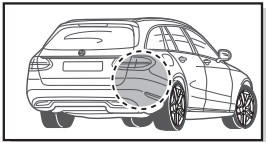
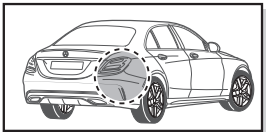

18

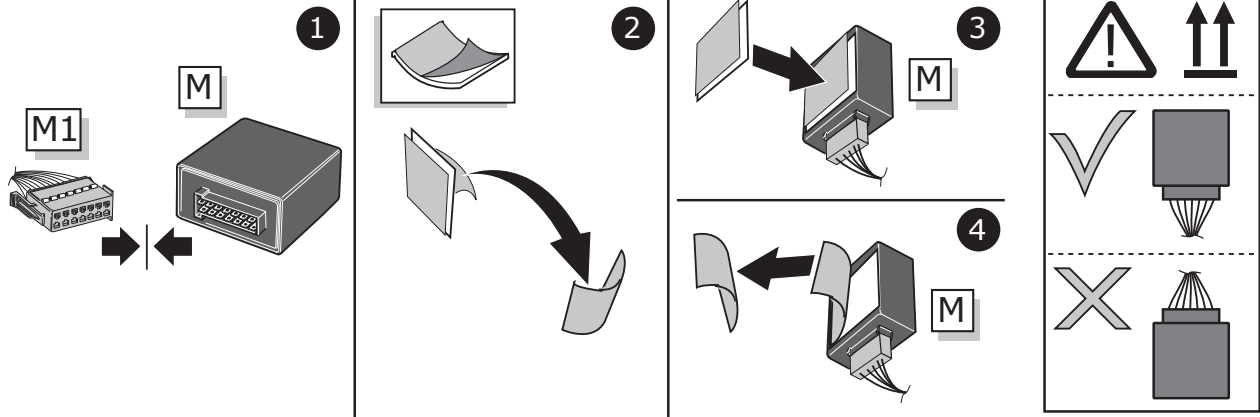

19

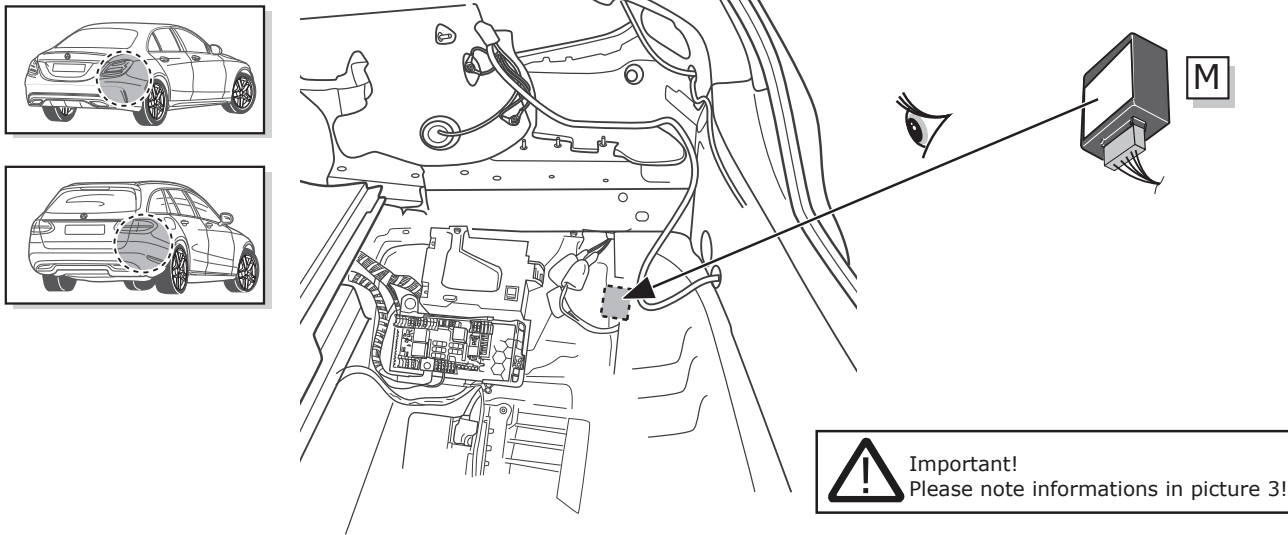

20

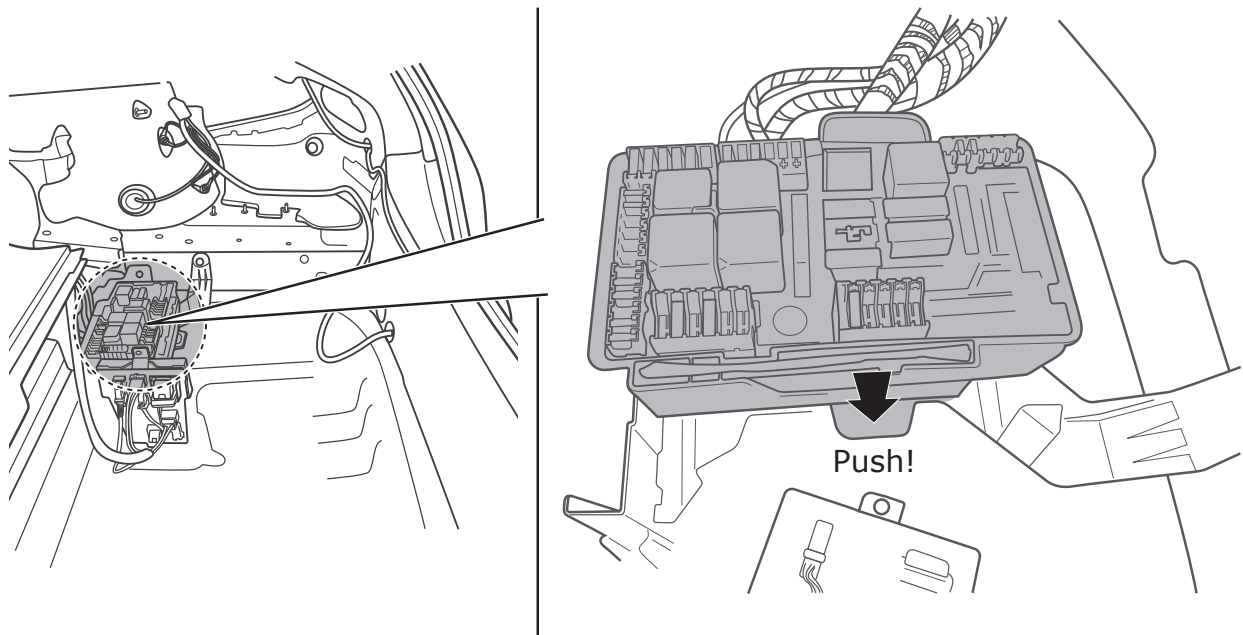

21

1

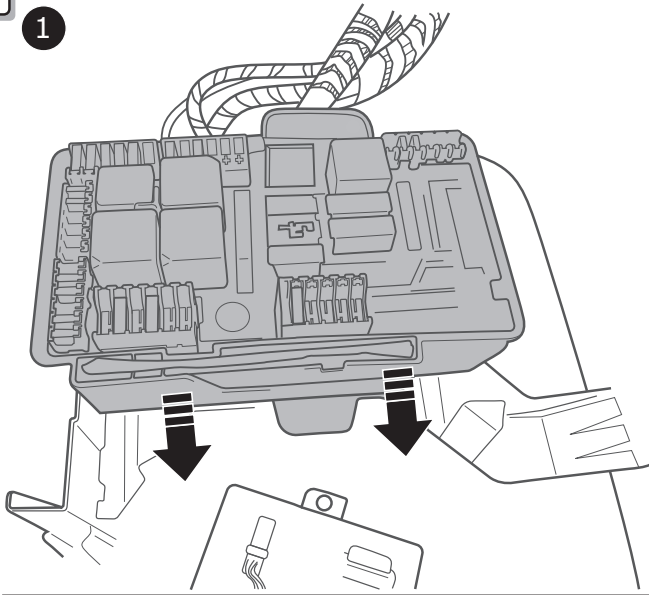

2

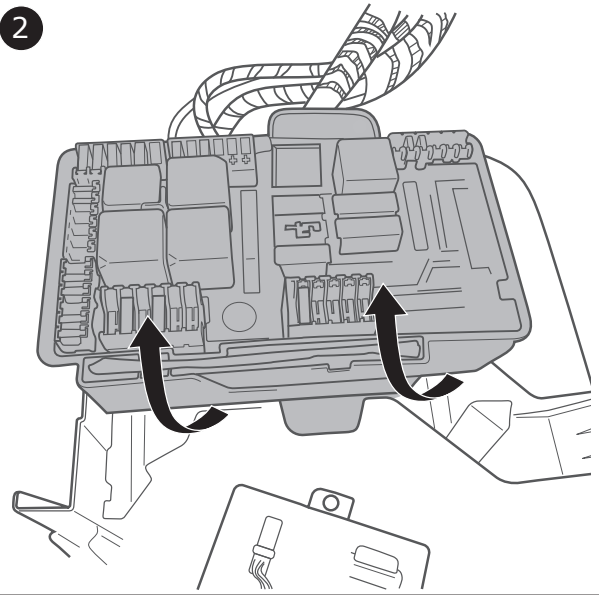

3

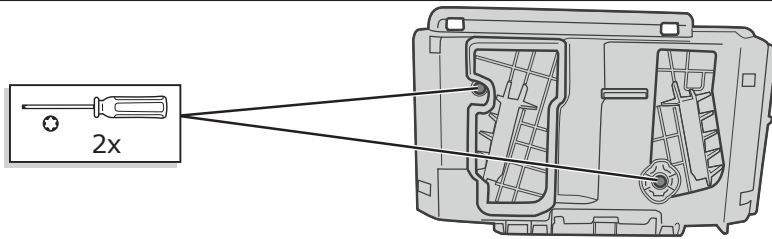

22

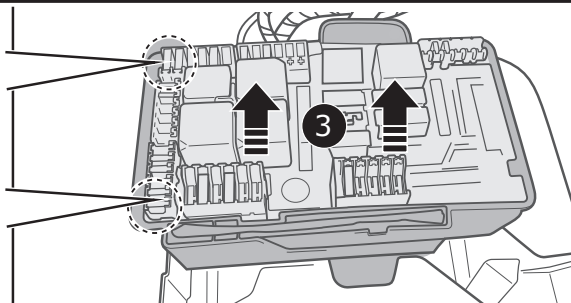
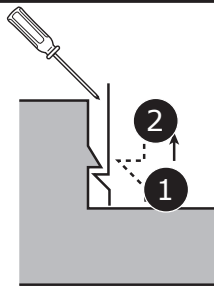

23

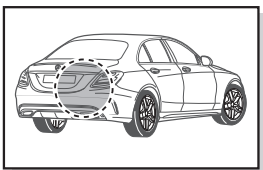

B+ /30

Option 1
PE

Option 2
BU

Option 3
GN

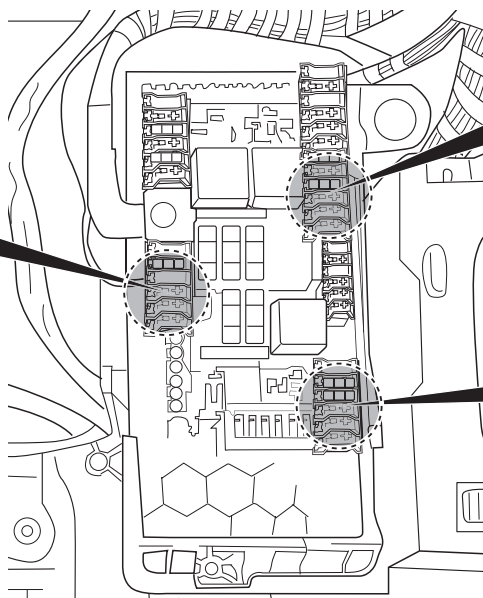

24

Suche 2 freie
Sicherungsplätze für
(B+/30)!

Locate 2 unoccupied
fuse plug-in positions
(B+/30)!

Option 1

Option 2

Option 3

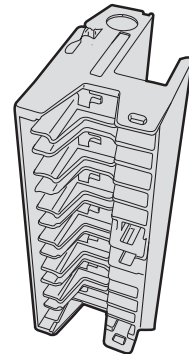
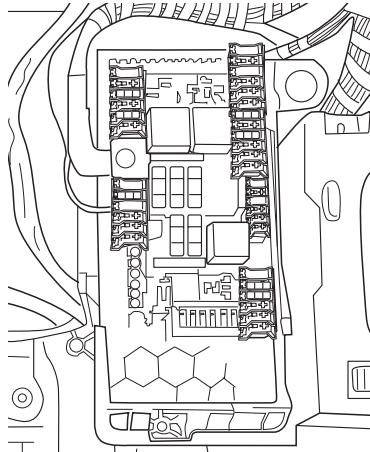



25

Option 1

Option 2

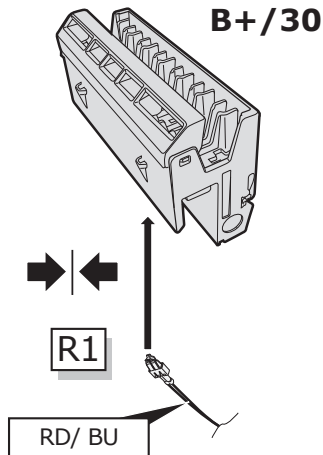
Option 3









 20 Amp.
minifuse
RD/BU

26



	 POS.
 RD/ BU 20 Amp. 

27

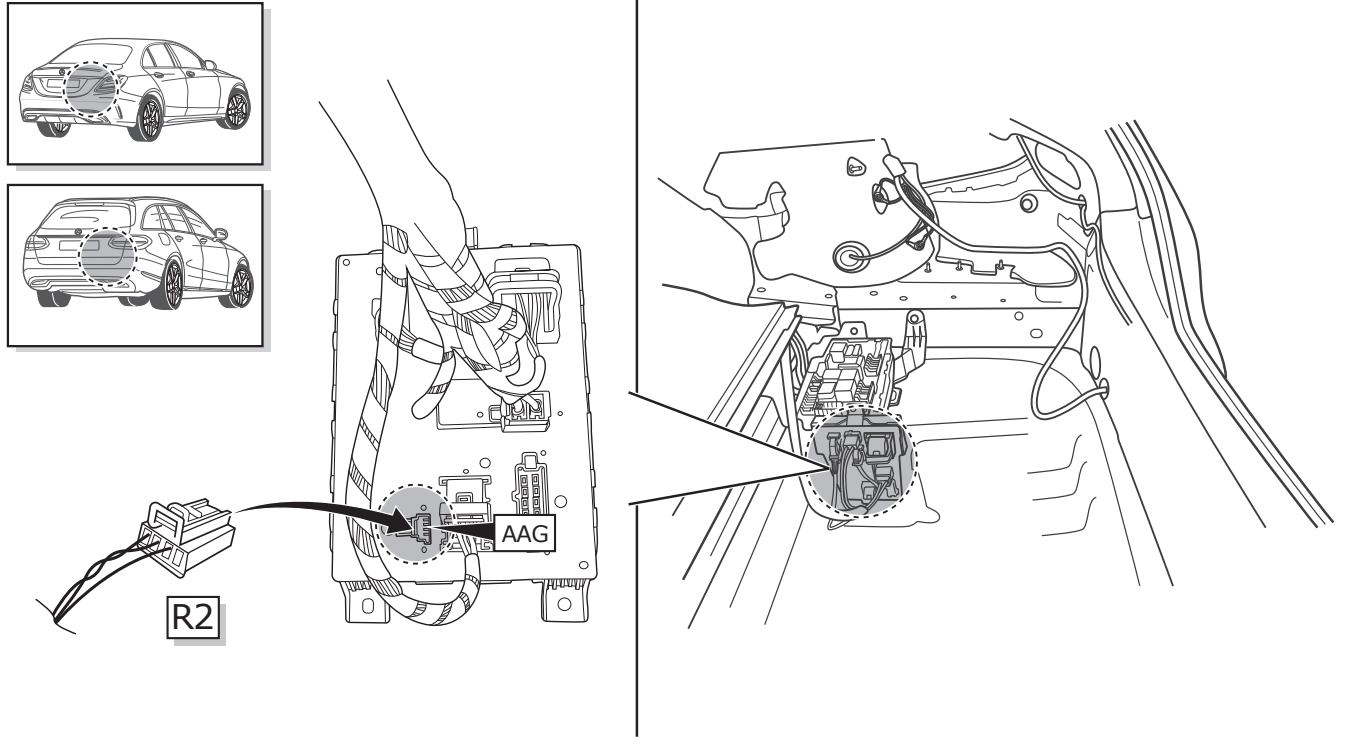

28

Optional

⚠ MAX = 21W

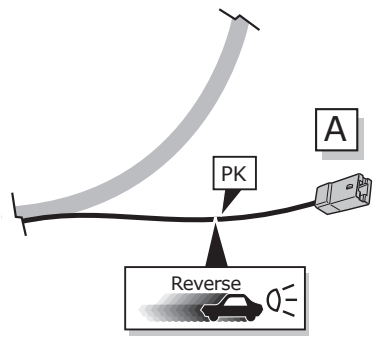
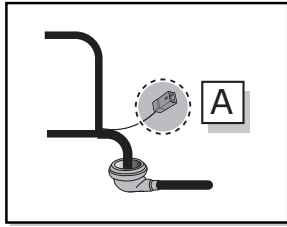

29

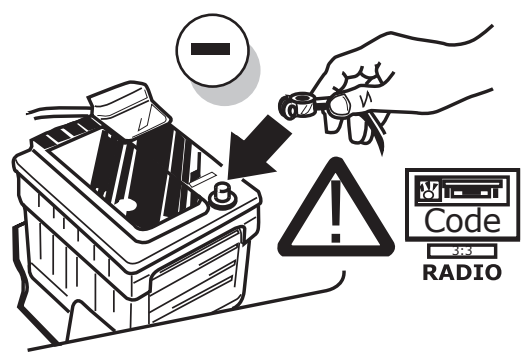

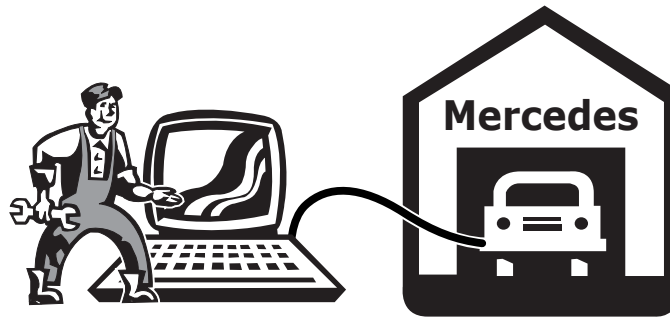

DE

GB

FR

Die Aktivierung der Anhängerfunktionen muss wie folgt durchgeführt werden:

1. Computer mit Auto verbinden
 2. Programm starten
 3. Klicke auf „Sonderfunktionen“
 4. Klicke auf "Eingabe bei Nachrüstungen oder Umbauten"
 5. Gebe Benutzername und Passwort ein
 6. Schreibe 550 beim oberen (+) Feld ein
 7. Akzeptiere und beende das Programm.
 8. Starte Programm erneut
 9. Klicke auf „Steuergeräte Ansicht“
 10. Verbaute Steuergeräte wie folgt programmieren:
 - a. Klicke z.B. auf „EZS“ (Elektronisches Zündschloss)
 - b. Klicke auf „Anpassung“
 - c. Auf der linken Seite: Klicke auf Aktualisierung SCN-Codierung
 - d. Gehe online und warte ein paar Sekunden
 11. Vorgang mit allen unten aufgeführten Steuergeräten durchführen:
 - „EZS“ (Elektronisches Zündschloss)
 - „SAM-hinten“ (Signalerfass- und Ansteuermodul hinten.)
 - „SAM-vorn“ (Signalerfass- und Ansteuermodul vorn)
 - „Kombiinstrument“
 - „Headunit/Audio 20“
 - „Motor“
- Wenn verbaut:
- „Parksystem“
 - „360°-Kamera“
 - „Niveau-Regulierung“
 - „KEYLESS-GO“

► Ende der Codierung

The activation of the trailer functions has to be carried as follows:

1. Connect computer to car
 2. Start program
 3. Click "Special functions"
 4. Click "Input for retrofits or conversions"
 5. Enter you user name and password
 6. Write 550 in the upper (+) field
 7. Accept and close the program.
 8. Start the program again
 9. Click "Controllers View"
 10. code installed control units as follows:
 - a. Click e.g. "EZS" (Ignition)
 - b. Click "Adjust"
 - c. On the left side: click updating SCN encoding
 - d. Go online a wait a few seconds
 11. Perform the operation with all the control units listed below:
 - "EZS" (Ignition)
 - "SAM-rear" (Signal detection- and control modul rear).
 - "SAM-front" (Signal detection- and control modul front).
 - "combined instrument"
 - "headunit/Audio 20"
 - "Engine"
- if fitted:
- "Parksystem"
 - "360° camera"
 - "Level Control"
 - "KEYLESS-GO"

► Coding finished

L'activation des fonctions de la remorque doit être effectuée comme suit:

1. Relier l'ordinateur à la voiture
 2. Démarrer le programme
 3. Cliquez sur «Fonctions spéciales»
 4. Cliquez sur «Saisie pour rééquipement ou transformation»
 5. Saisissez le nom d'utilisateur et le mot de passe
 6. Inscrivez 550 dans la zone(+) en haut
 7. Acceptez et quittez le programme
 8. Redémarrez le programme
 9. Cliquez sur «Vue appareils de commande»
 10. Programmez des appareils de commande montés comme suit:
 - a. Cliquez p. ex. sur «EZS» (Allumage)
 - b. Cliquez sur «Adaptation»
 - c. Sur le côté gauche: Cliquez sur actualisation SCN Codage
 - d. Rendez-vous en ligne et attendez quelques secondes
 11. Effectuer la procédure avec toutes les unités de commande dans la liste ci-dessous:
 - «EZS» (Allumage)
 - «SAM-arrière»(Module de Commande en arrière)
 - «SAM-devant»(Module de Commande devant)
 - «instrument combiné»
 - «headunit/Audio 20»
 - «moteur»
- si installé:
- «Système de stationnement»
 - «Caméra panoramique»
 - «Contrôle de niveau»
 - «KEYLESS-GO»

► Fin de codage



IT

ES

NL

L'attivazione di rimorchio funzioni si deve eseguire come segue:

1. Collegare il computer con l'auto
 2. Avviare il programma
 3. Cliccare su „Funzioni speciali“
 4. Cliccare su "Immissione in caso di optional supplementari o modifiche"
 5. Digitare il nome utente e la password
 6. Digitare 550 nel campo superiore (+)
 7. Accettare e chiudere il programma.
 8. Riavviare il programma
 9. Cliccare su „Vista Comando centralina“
10. codite unità di controllo installato come segue
- a. Cliccare p.es. „EZS“ (Blocco di accensione)
 - b. Cliccare su „Adattamento“
 - c. Sul lato sinistro:
cliccare su attualizzazione SCN Codifica
 - d. Collegarsi online e aspettare alcuni secondi
11. Eseguire la procedura con tutte le centraline di seguito elencati:
- „EZS“ (Blocco di accensione)
 - „SAM dietro“ (Modulo di controllo dietro)
 - „SAM avanti“ (Modulo di controllo avanti)
 - „strumenta combinato“
 - „headunit/Audio 20“
 - „motore“
- se installato:
- "Sistema di parcheggio"
 - „Telecamera a 360°“
 - „Controllo di livello“
 - „KEYLESS-GO“
- Fine della codifica

La activación del funciones de remolque deberá llevarse a cabo de la siguiente manera:

1. Conectar el ordenador con el coche
 2. Iniciar el programa
 3. Hacer clic en "Funciones especiales"
 4. Hacer clic en "Entradas en caso de reequipamientos o modificaciones"
 5. Introducir el nombre de usuario y la contraseña
 6. Introducir 550 en la casilla superior (+)
 7. Aceptar la entrada y finalizar el programa.
 8. Volver a iniciar el programa
 9. Hacer clic en "Ver reguladores"
10. código instalado unidades de control de la siguiente
- a. Hacer clic por ejemplo en "EZS" (Ignición)
 - b. Hacer clic en "Adaptación"
 - c. En el lado izquierdo: Hacer clic en actualización SCN Codificación
 - d. Conectarse en línea y esperar un par de segundos
11. Realice el procedimiento con todas las unidades de control que se indican a continuación:
- "EZS" (Ignición)
 - "SAM-atrás" (Módulo de control atrás)
 - "SAM-delante" (Módulo de control delante)
 - "instrumento combinado"
 - "headunit/Audio 20"
 - "motor"
- si está instalado:
- "Sistema de estacionamiento"
 - "Cámara de 360°"
 - "Control de nivel"
 - "KEYLESS-GO"
- Fin de la codificación

De activering van de trailerfuncties moet als volgt worden uitgevoerd:

1. Computer met auto verbinden
 2. Programma starten
 3. Klik op „Speciale functies“
 4. Klik op "Invoer bij achteraf toegevoegde onderdelen of modificaties"
 5. Voer gebruikersnaam en wachtwoord in
 6. Schrijf 550 in het bovenste (+) veld
 7. Accepteer en beëindig het programma.
 8. Start programma opnieuw
 9. Klik op „ Bekijk besturingsapparaten“
10. code geïnstalleerd besturingsapparaten als volgt
- a. Klik bijvoorbeeld op „EZS“ (Ignition)
 - b. Klik op „Aanpassing“
 - c. Aan de linkerkant:
klik op update SCN-codering
 - d. Ga online en wacht een paar seconden
11. Voer de proces met alle hieronder genoemde besturingsapparaten:
- „EZS“ (Ignition)
 - „SAM achter“ (Signal detection- and control modul achter)
 - „SAM vooraan“ (Signal detection- and control modul vooraan)
 - „kombi-instrument“
 - „headunit/Audio 20“
 - „motor“
- indien geïnstalleerd:
- „Parking system“
 - „360°-camera“
 - "Level Control"
 - "KEYLESS-GO"
- Uiteinde van het coderende

30

Functional test

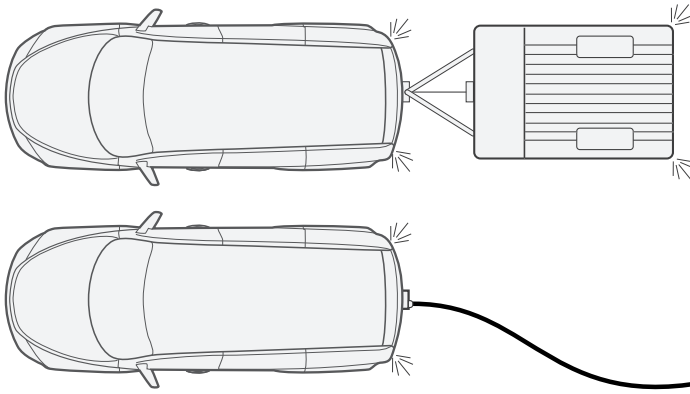
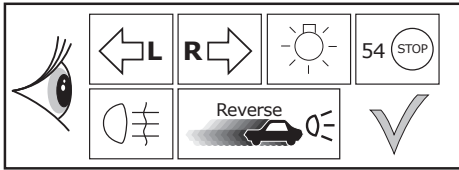

LIGHTMATE

ECS part no.
LIGHTMATEII
LIGHTMATEIII

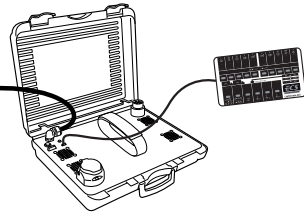

31

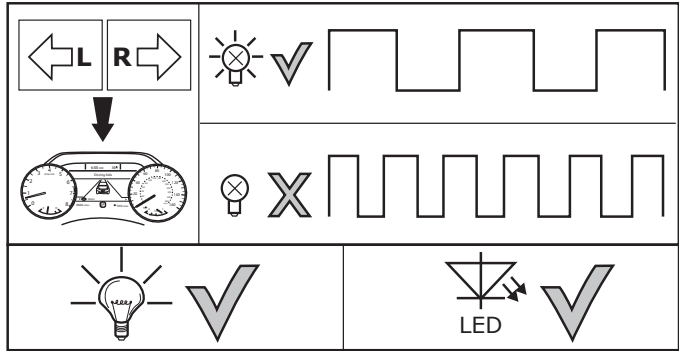
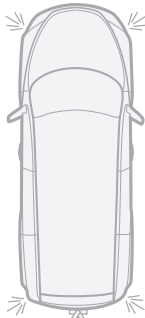

32

Optional

Adapter socket

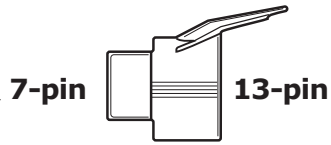
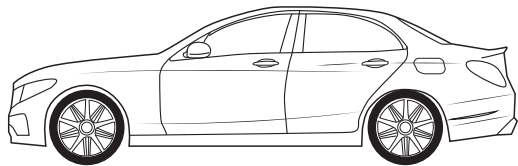

ECS part no.
SP-126-ZZ

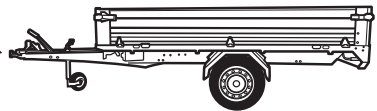

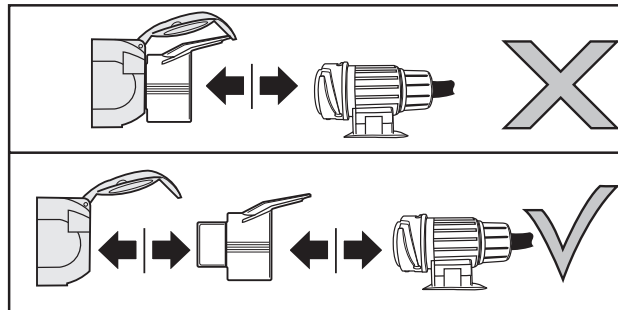
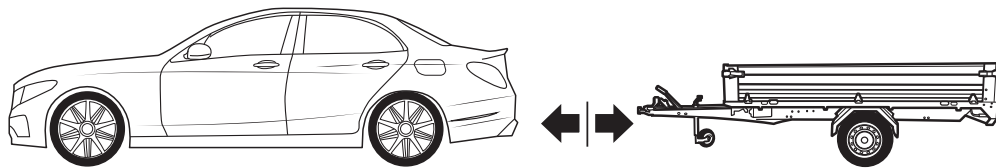





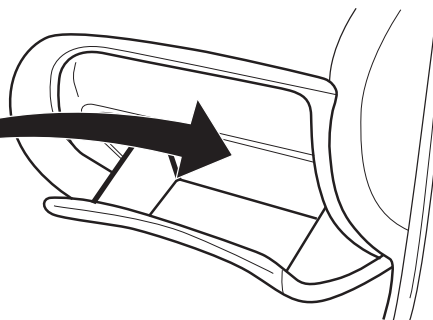
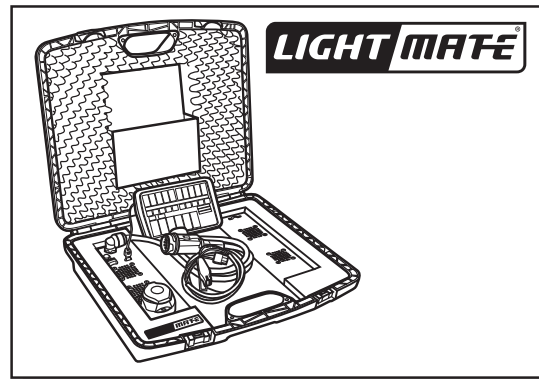
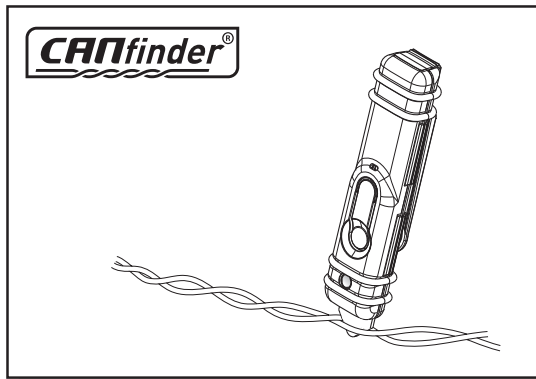

INFO

Products & Service: www.ecs-electronics.nl

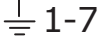

INFO

- | | |
|--|--------------------------------------|
| (DE) Anschluss Steckdose | (CZ) Objímkový konektor |
| (FR) Connection de la prise | (DK) Stikdåse forbindelse |
| (NL) Contactdoos aansluiting | (FI) Pistorasia liitäntä |
| (GB) Socket connection | (GR) Υποδοχή σύνδεσης |
| (ES) Conexión de la caja de enchufe | (NO) Tilkobling koblingsboks |
| (IT) Allaccio zoccolo | (PL) Połączenie przez gniazdo |
| (SE) Anslutning kontaktdosa | |

DIN/ISO 1724							
	1/L	2	3/31	4/R	5/58-R	6/54	7/58-L
Pmax	21W	21W		21W	52W	3x21W	52W
(DE)	Gelb	Blau	Weiß	Grün	Braun	Rot	Schwarz
(FR)	Jaune	Bleu	Blanc	Vert	Marron	Rouge	Noir
(NL)	Geel	Blauw	Wit	Groen	Bruin	Rood	Zwart
(GB)	Yellow	Blue	White	Green	Brown	Red	Black
(ES)	Amarillo	Azul	Blanco	Verde	Marrón	Rojo	Negro
(IT)	Giallo	Blu	Bianco	Verde	Marrone	Rosso	Nero
(SE)	Gul	Blå	Vit	Grön	Brun	Röd	Svart
(CZ)	Žlutá	Modrá	Bílá	Zelená	Hnědá	Červená	Černá
(DK)	Gul	Blå	Hvid	Grøn	Brun	Rød	Sort
(FI)	Keltainen	Sininen	Valkoinen	Vihreä	Ruskea	Punainen	Musta
(GR)	Κίτρινο	Μπλε	Λευκό	Πράσινο	Καφέ	Κόκκινο	Μαύρο
(NO)	Gul	Blå	Hvit	Grønn	Brun	Rød	Svart
(PL)	Żółty	Niebieski	Biały	Zielony	Brązowy	Czerwony	Czarny